

Data sheet 4MV 420

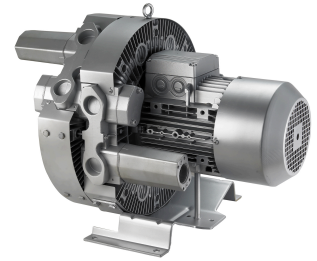

Performance curve for Vacuum pump

Performance curve for Compressor

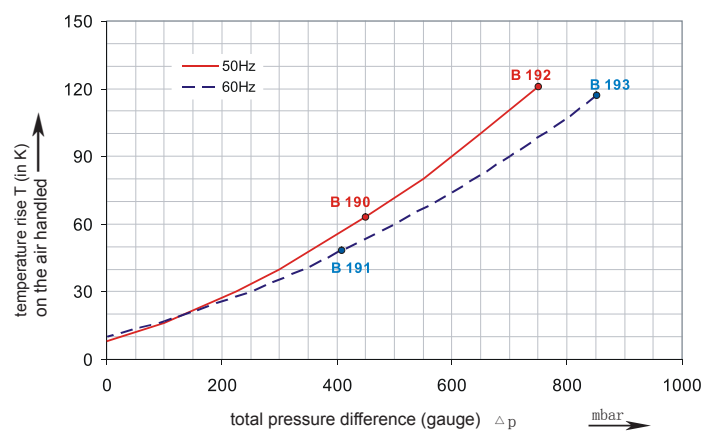
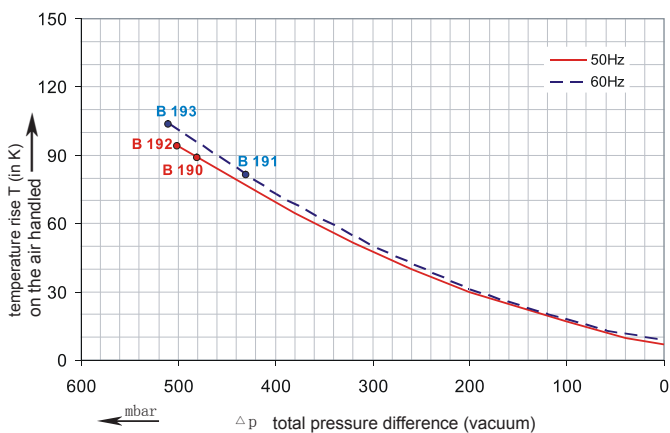
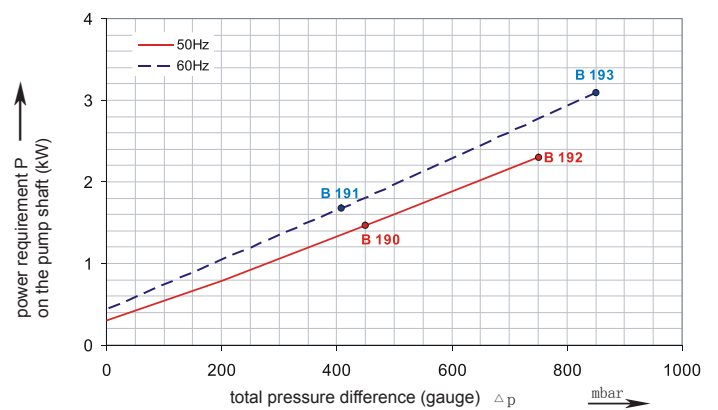
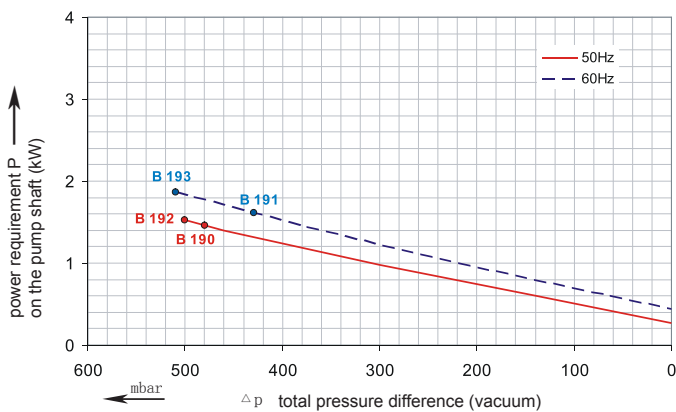
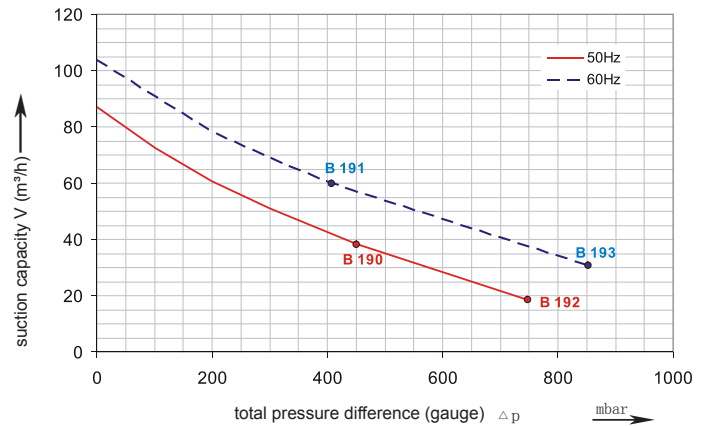
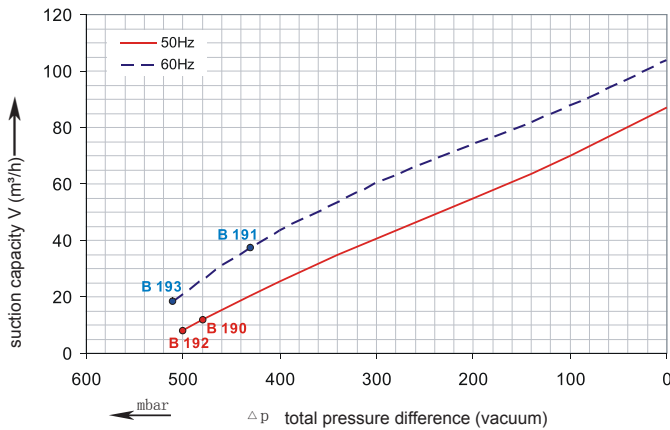

The performance curves of Manvac blower is tested through below ways: Under one atmospheric pressure, suck 15°C air and then you can calculate the data, of course allow 10% difference, and when the sucked air and surroundings temperature are not higher than 25°C, you still can get total pressure difference as the curves shows.

Selection and ordering data

Type 4MV420

Curve No.	Order No.	Fre- quency	Rated power	Input voltage		Input current		Permissible total differential pressure ²⁾		Sound pressure level ³⁾	Weight ca.
								Vacuum mbar	Compressor mbar		
		Hz	kW	V		A					
3~ 50/60 Hz IP55 isulation material class F 1)											
B 190	4MV420 H26	50	1.5	200D ... 240D	345Y...415Y	7.5D	4.3Y	-480	450	61	33
B 191	4MV420 H26	60	1.75	220D ... 275D	380Y...480Y	7.6D	4.4Y	-430	410	66	33
B 192	4MV420 H56	50	3.3	200D ... 240D	345Y...415Y	13.0D	7.5Y	-500	750	61	39
B 193	4MV420 H56	60	3.8	220D ... 275D	380Y...480Y	13.8D	8.0Y	-510	850	66	39

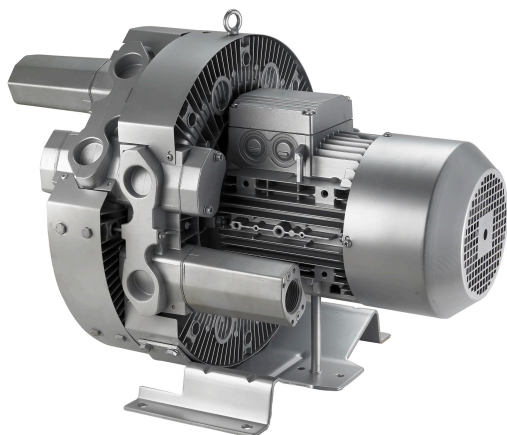

Other voltage ranges

		4MV420	<input type="checkbox"/>	<input type="checkbox"/>
50Hz	60Hz		↑	↑
3~				
185...225 V D/320...390 V Y	200...240 V D/345...415 V Y	H	1	
200...240 V D/345...415 V Y	200...275 V D/380...480 V Y	H	6	
345...415 V D	380...480 V D	H	7	
500 V D	575VD	C	5	

Further voltage range on request; please quote in plain text.

Dongguan Mingkai Electromechanical Co., Ltd.

Add: C712 Mingzhi Building, Nancheng District,

Dongguan, Guangdong, China. 523000 Cell/whatsapp:

+86-137-1292-7830 Tel: +86-769-28639650 Website:

www.manvac.cn www.manvacblowers.com